

I

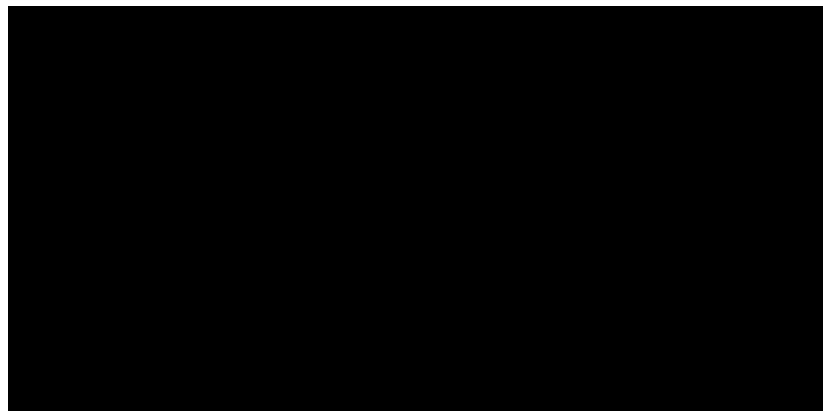

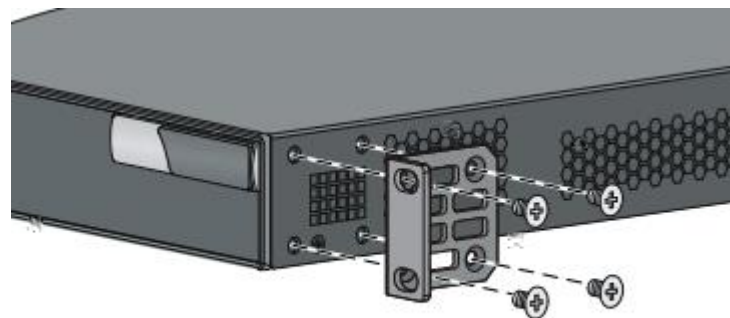

19



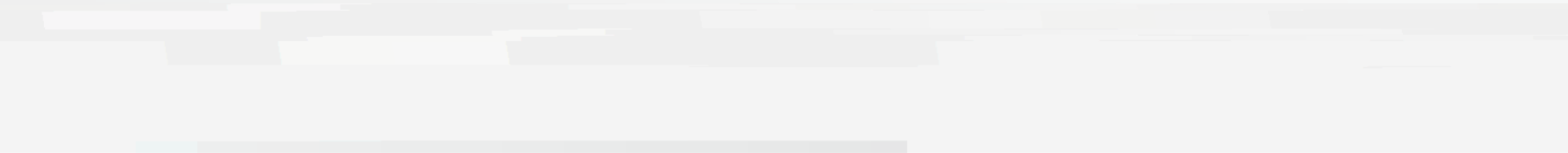

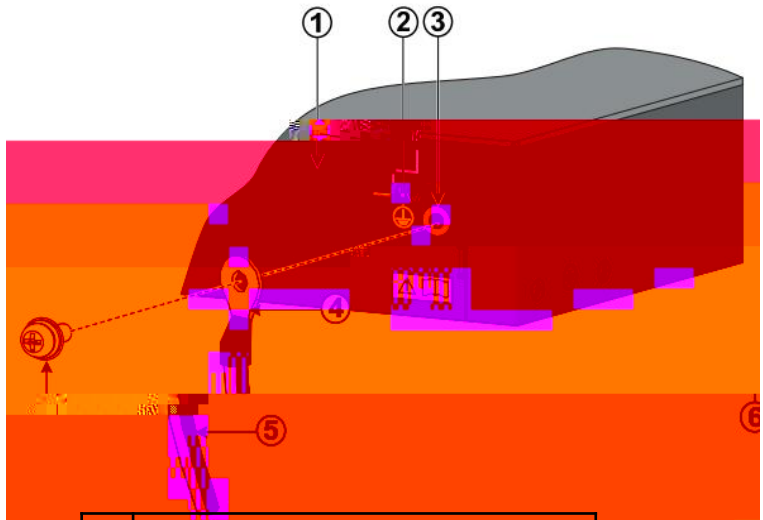



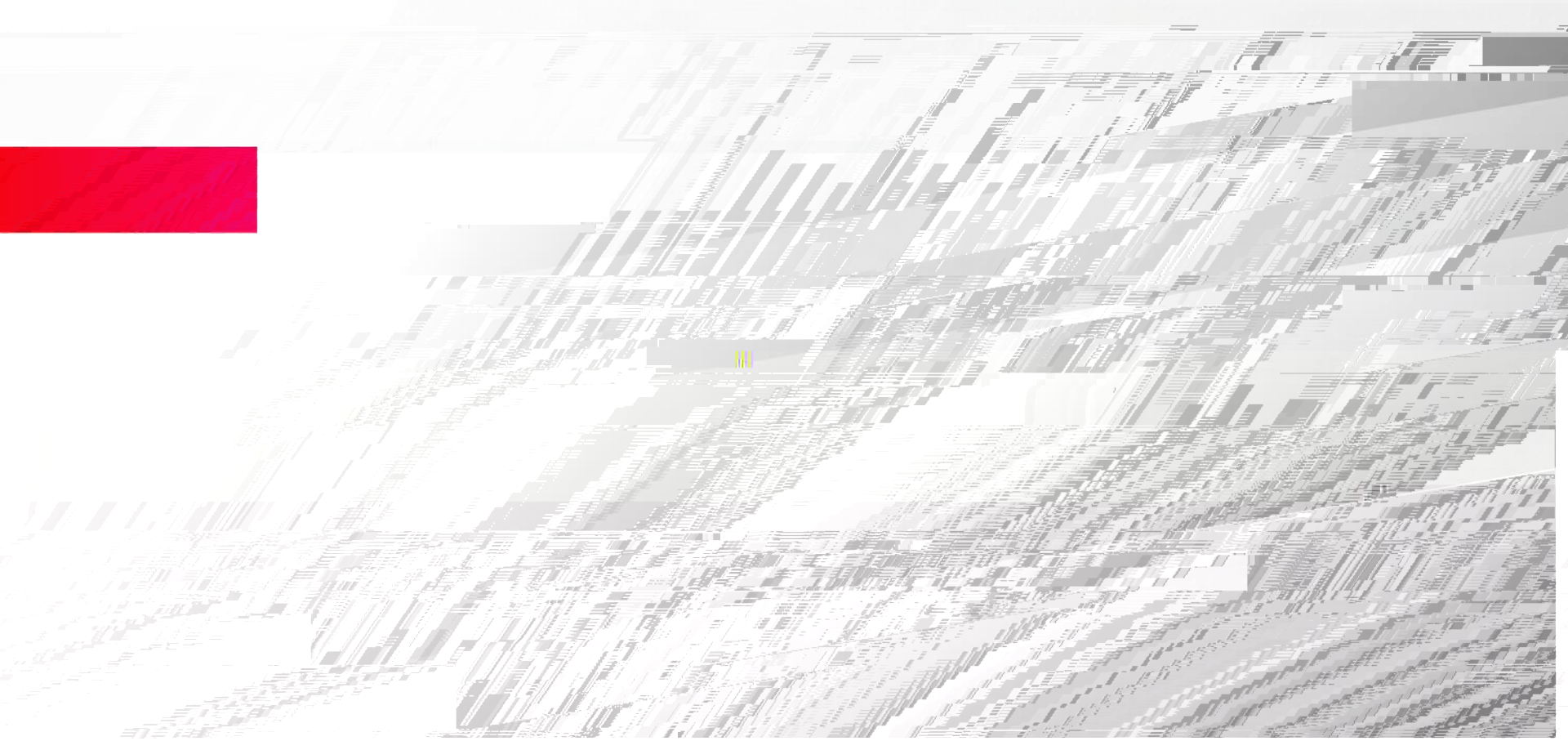



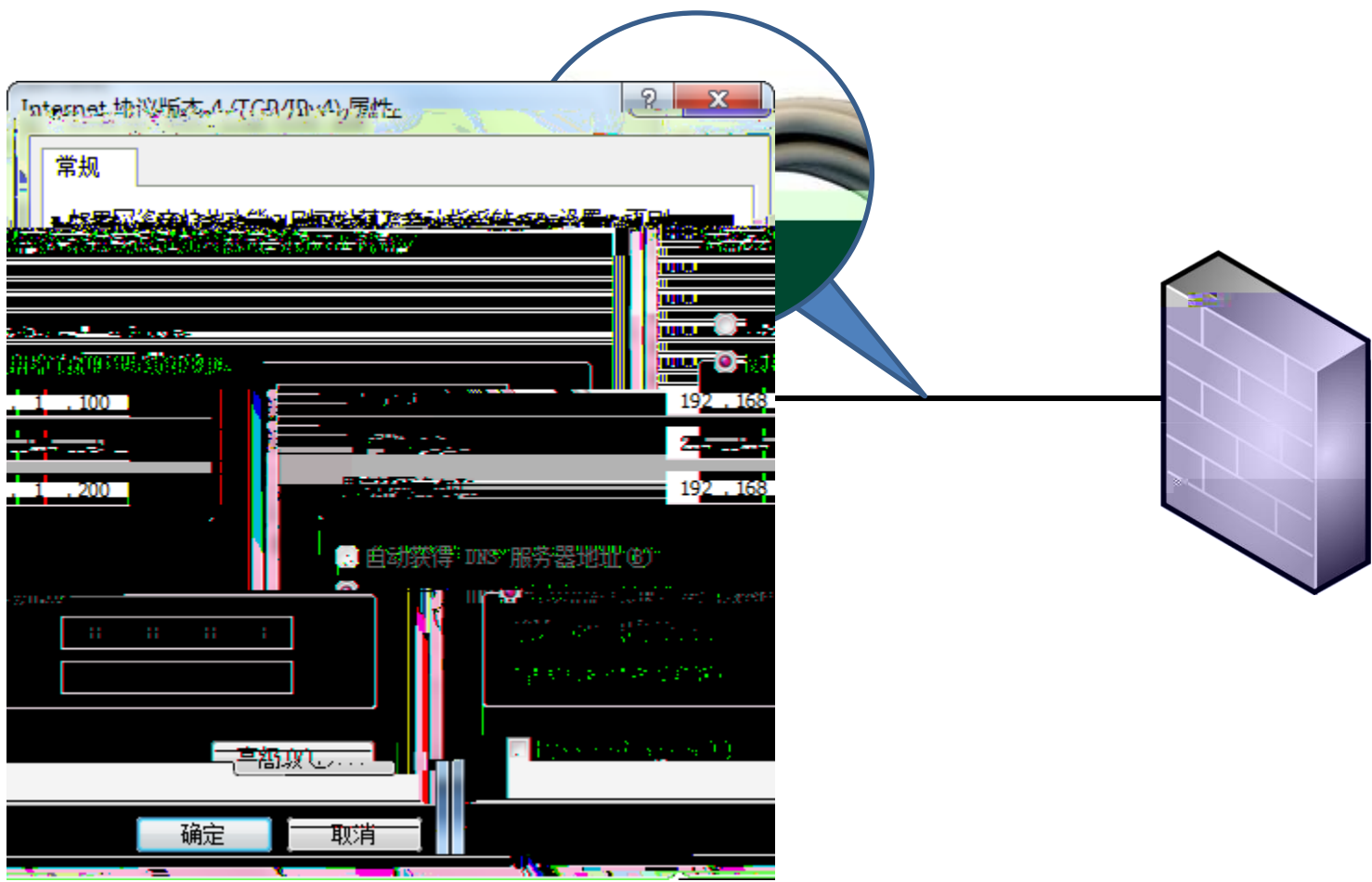

Windows Internet Explorer 8
<https://192.168.1.200/medial/main.htm>

防务系统 Favorites RG-IDP系列入侵检测

主页 系统 网络 防务防御 IPS 告警 入侵检测 帮助 系统 告警 系统 告警 系统 告警

2015-05-18 18:34:21 RG-IDP admin

系统信息

型号: RG-IDP500E
 软件名称: RG-IDP系列入侵检测系统

资源使用情况

0%
35%
0%
0%
1%

接口状态

规则版本	引擎版本
2.0.44	2.0.0
2.0.4	2.0.0
2.0.8	2.0.0
2.0.3	2.0.0
2.0.2	2.0.0
1.3.17	1.3.0
2.0.3	2.0.0
2.0.1	2.0.0
2.0.4	2.0.0
2.0.6	2.0.0
2.0.2	2.0.0
1.4.46	1.4.0

资源使用情况

日志存储空间: 会话

软件版本	V1.0-R1.0.p0-20150512	NAT
序列号	000C29F3DE62	内存
License		策略
内存	2048 MB	VPN
系统运行时间	0 天 1 小时 17 分	CPU

接口状态 更多

IPS: eth0 eth1 eth2 eth3

IPS版本

规则库
HTTP
DNS
FTP
IMAP
ORACLE
OTHERS
POP3
SIP
SMTP
TELNET
TFIP
BACKDOOR

111 000 北京星网锐捷网络技术有限公司 [锐捷论坛: bbs.ruijie.com.cn](http://bbs.ruijie.com.cn) 技术支持电话: 4008

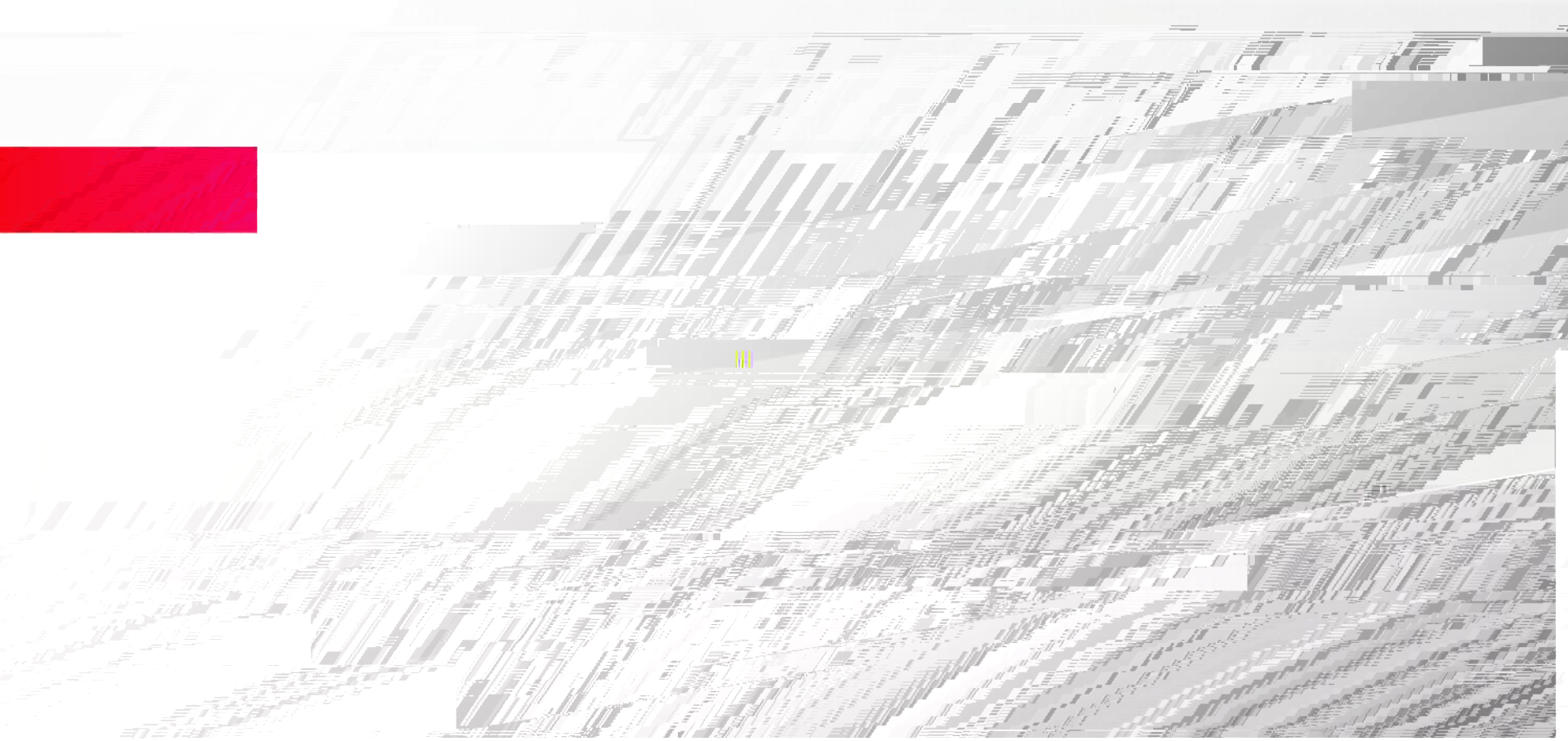

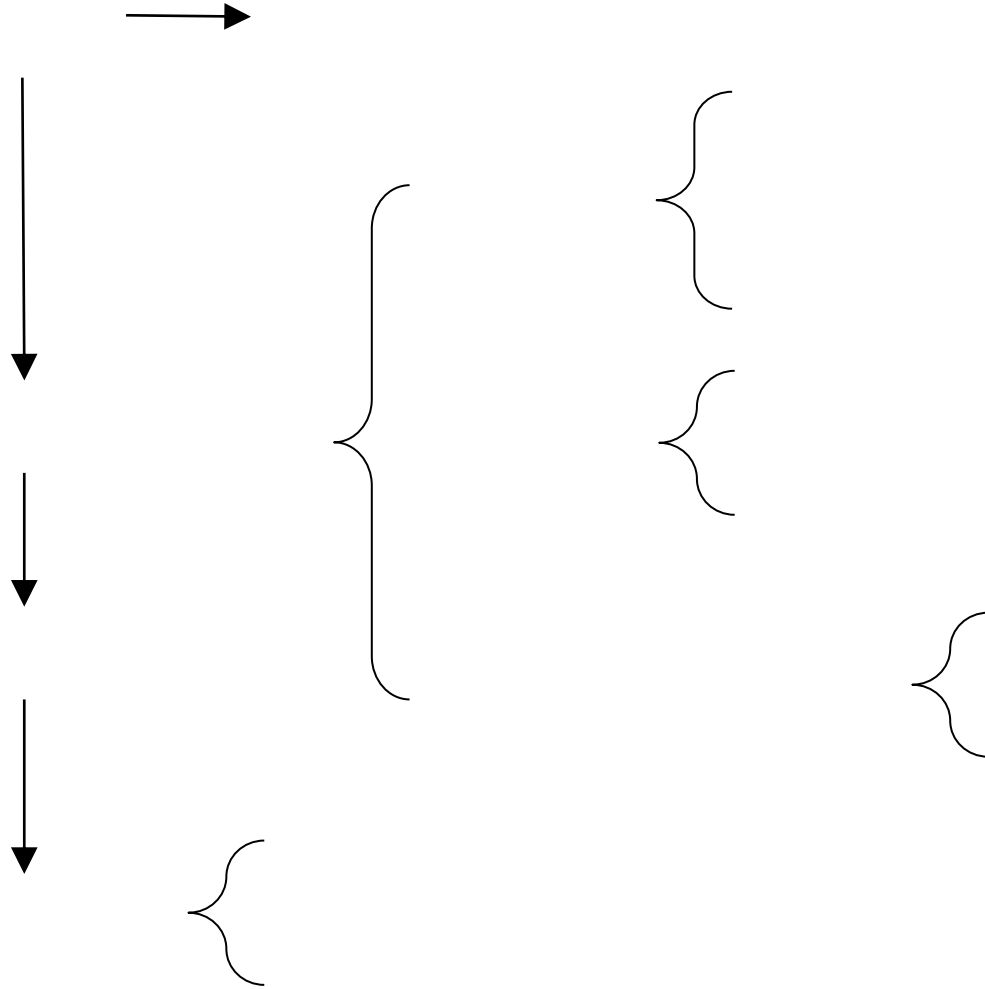



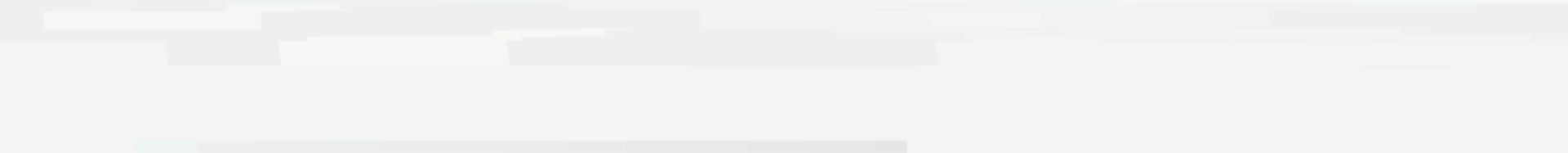

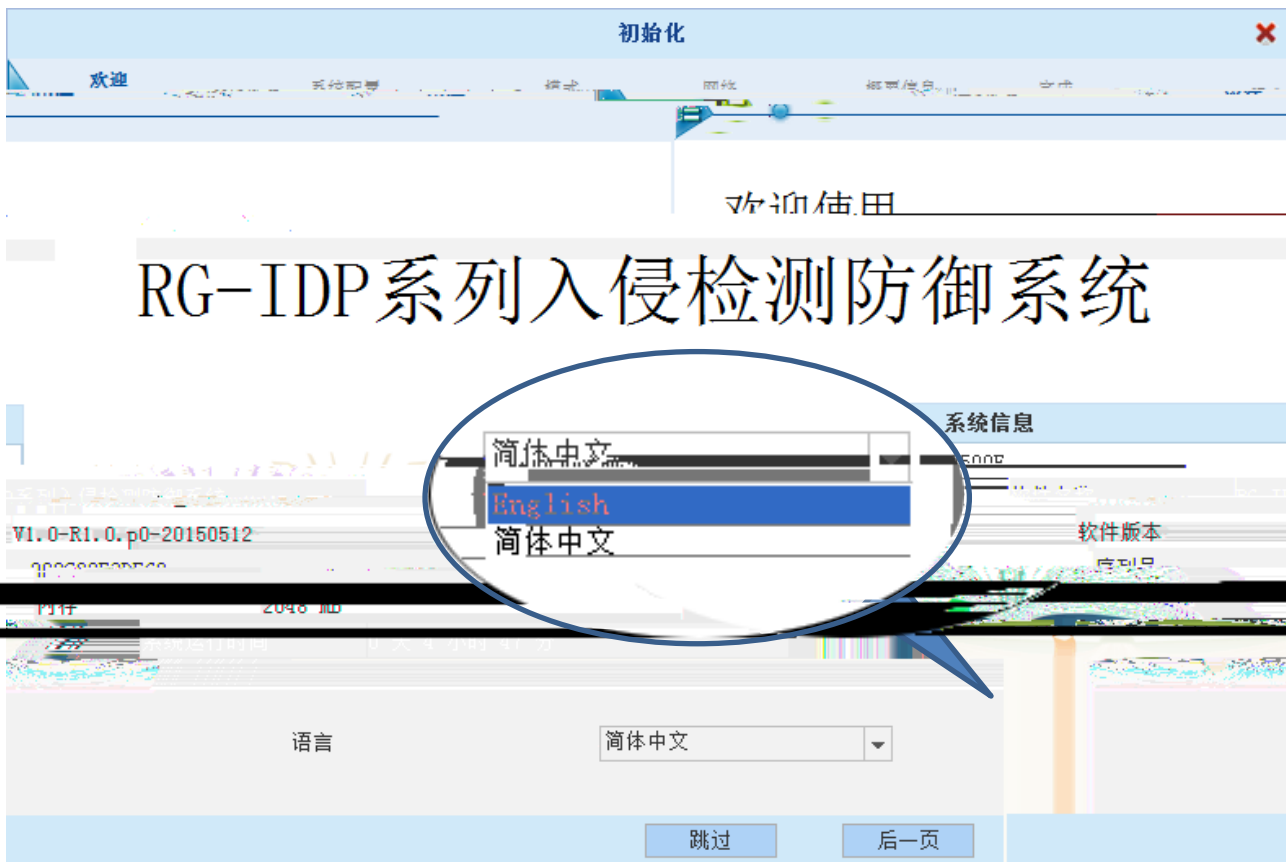

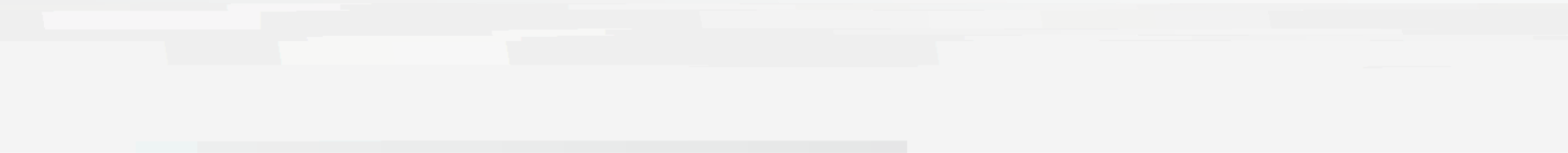

选择模式

透明模式

路由模式



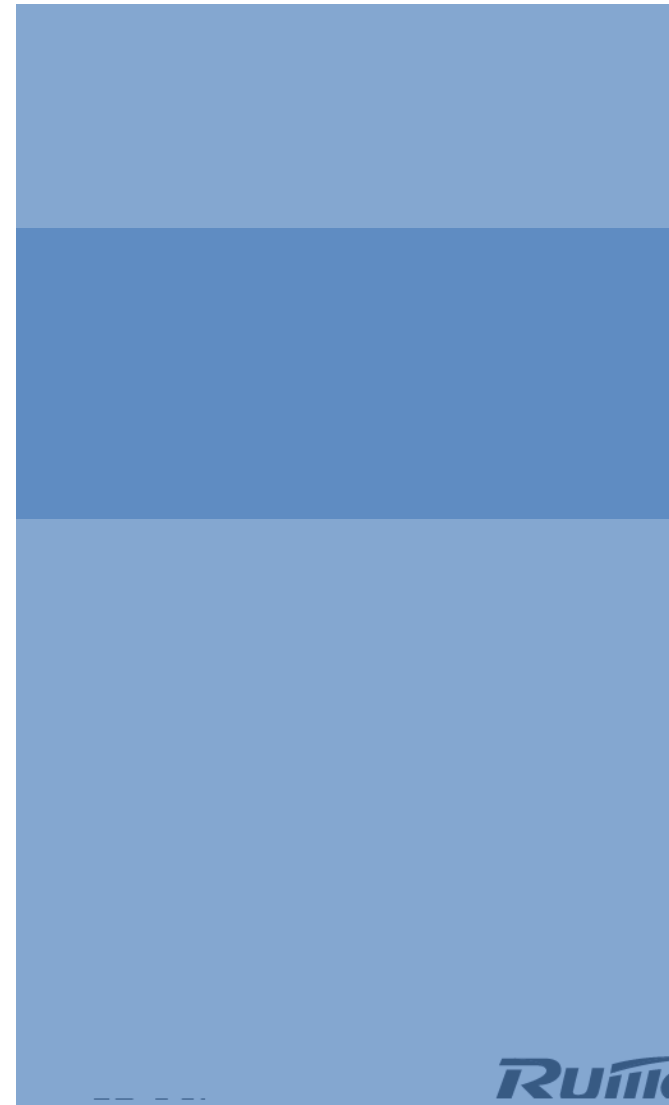
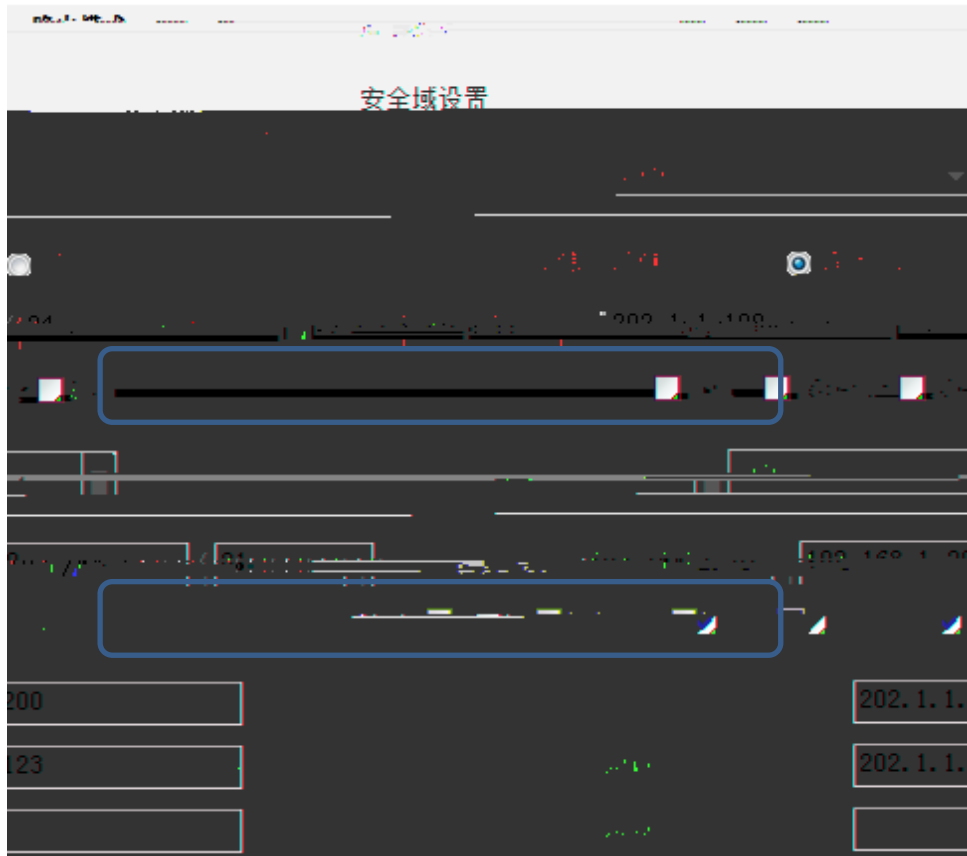



概述

名称	RG-100	地址	192.168.1.1
三科名	RG-IDP		
时区	(GMT+08:00) 中国/上海/北京		
日期时间	2015-05-18 22:18:06		
模式	路由模式		

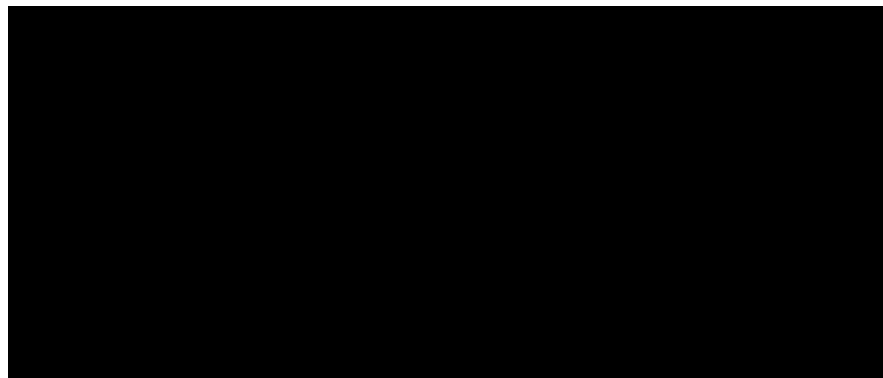

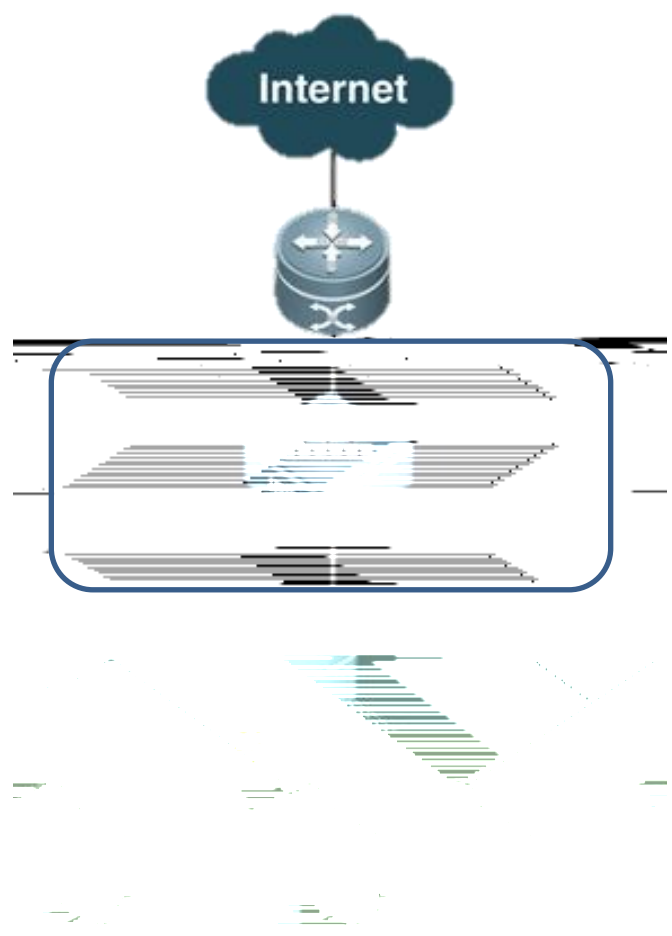



RG-IDP系列入侵检测防御系统



主机名

RG-IDP *

时区

(GMT+08:00) 中国/上海 (北京) ▼

日期

2015-05-18  * (YYYY-MM-DD)

时间

00:15:01



选择模式

透明模式

路由模式

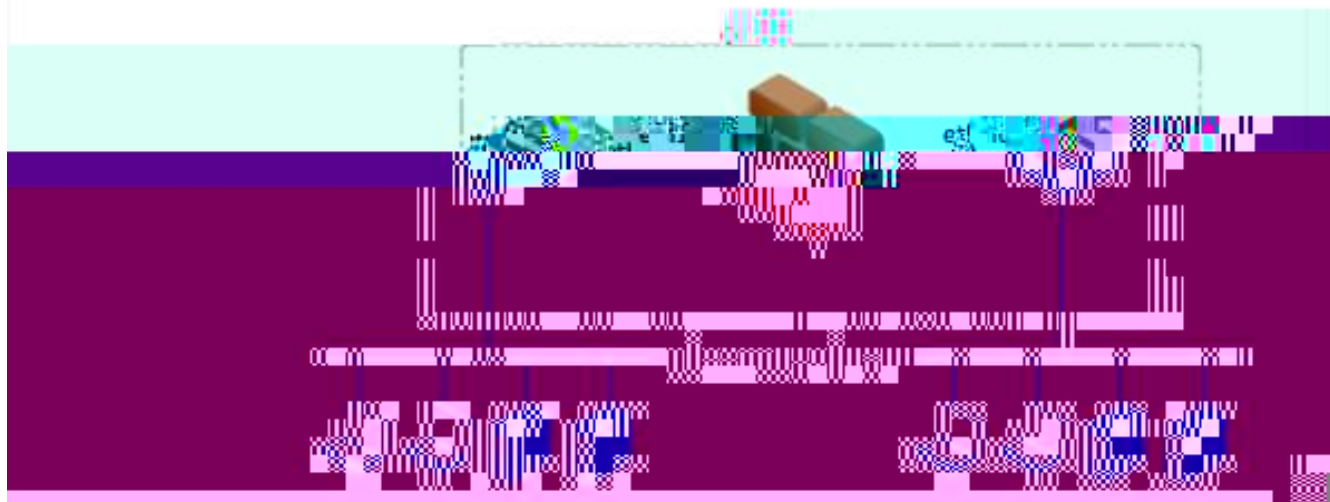

透明模式

安全域设置

WAN

LAN

IP地址/掩码 / *

网关

首选DNS

备选DNS

服务配置

SSH Telnet Ping Web

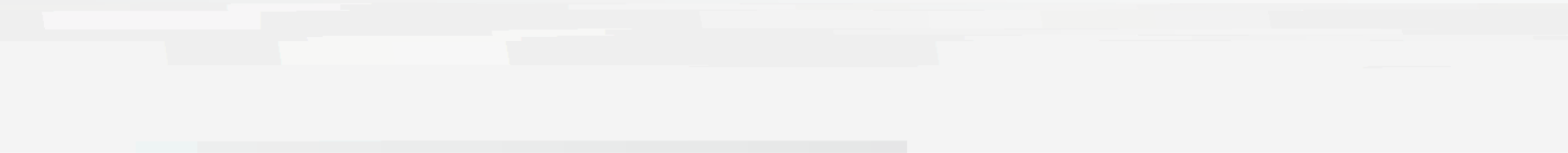

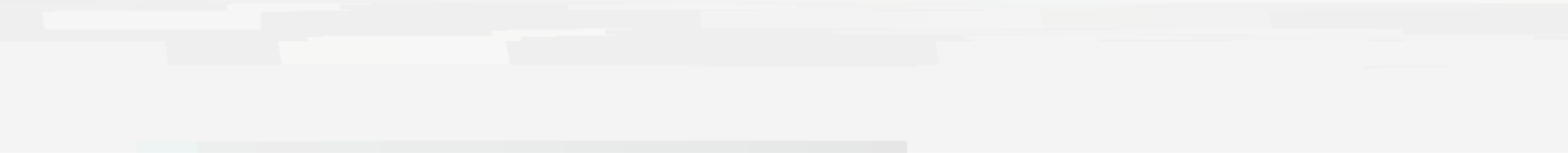



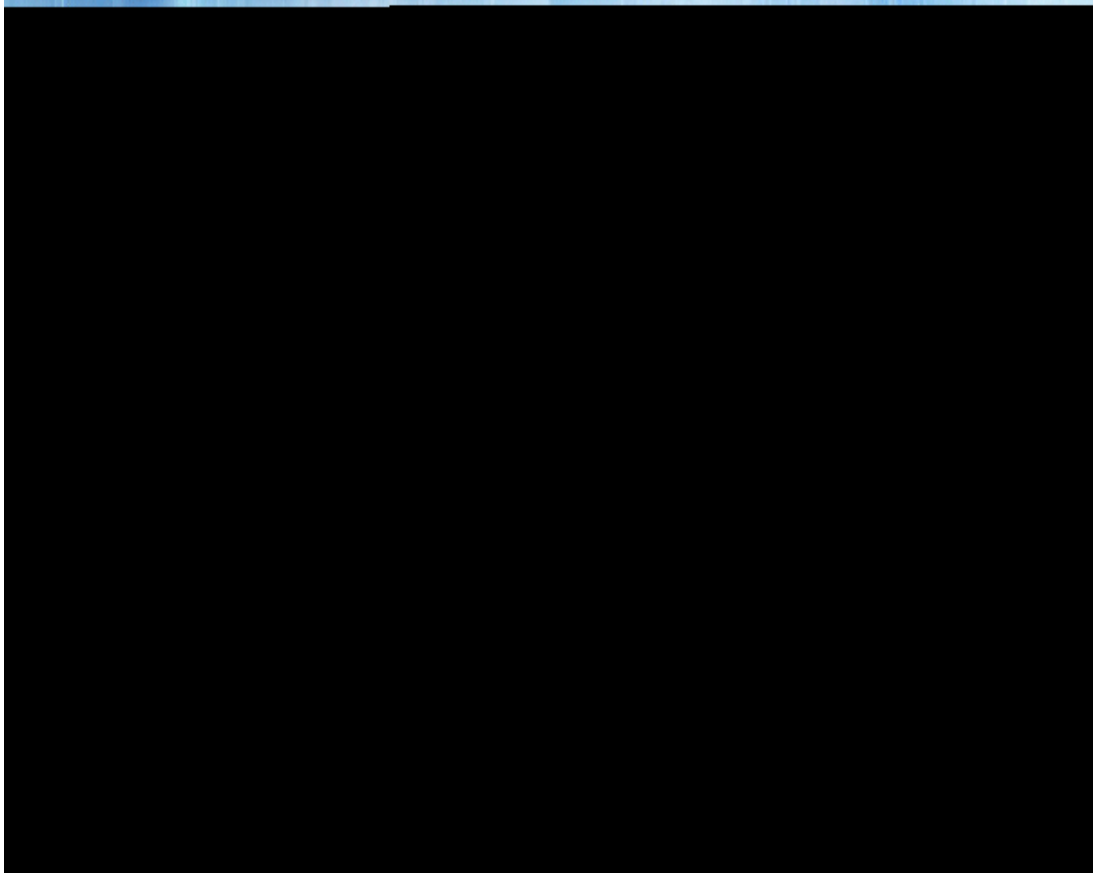







▶ IPS ▶ IPS ▶ 常规设置

TPS防护配置 ... [monitor a]]

启用自定义IPS规则

网络列表 (总数: 0) [添加] ▶

IP地址	类型

被保护网

空列

[确定] [取消]

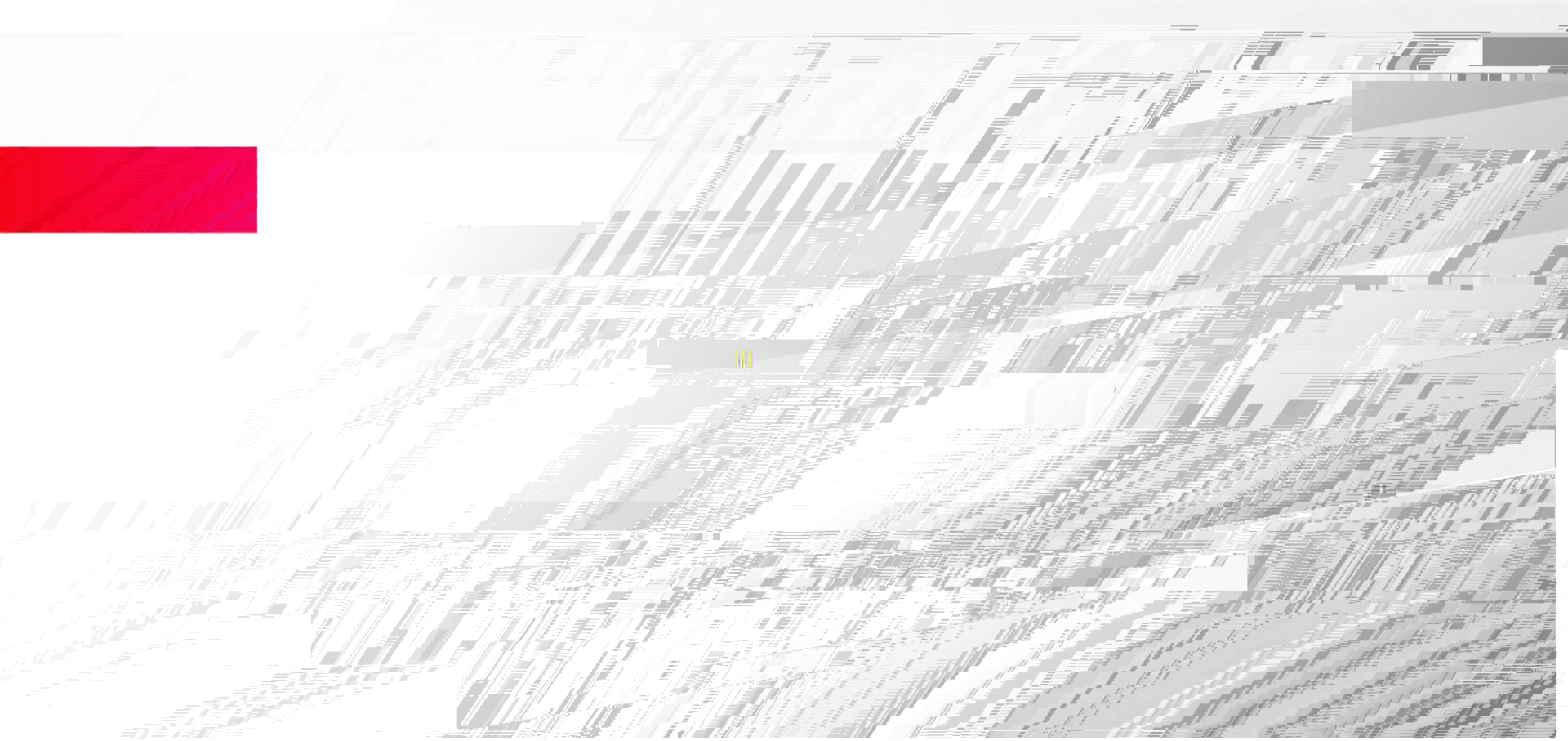



▼ 系统信息	
型号	RG-IDP-2000E
软件名称	RG-IDP系列入侵检测防御系统
软件版本	V1.0-R1.0, p0-20150620
软件序列号	448A5BF435E0
硬件序列号	H1GD9P8012345



License管理 License management

系统管理 > License管理

License管理

每页显示 10

操作 软件序列号 硬件序列号 型号 获取方式 创建时间 有效期 状态 学群激活码

操作	软件序列号	硬件序列号	型号	获取方式	创建时间	有效期	状态	学群激活码



新增License

* 软件序列号：

请在主页—系统信息—硬件序列号查看。
如H1GD9P80XXXXX

IDP1000E

下载

硬件序列号：
设备型号：
获取授权方式：
* 升级激活码

如需将多个激活码绑定到同台设备，需使用逗号隔开（逗号不能是中文编码），
如：XXXX,YYYY

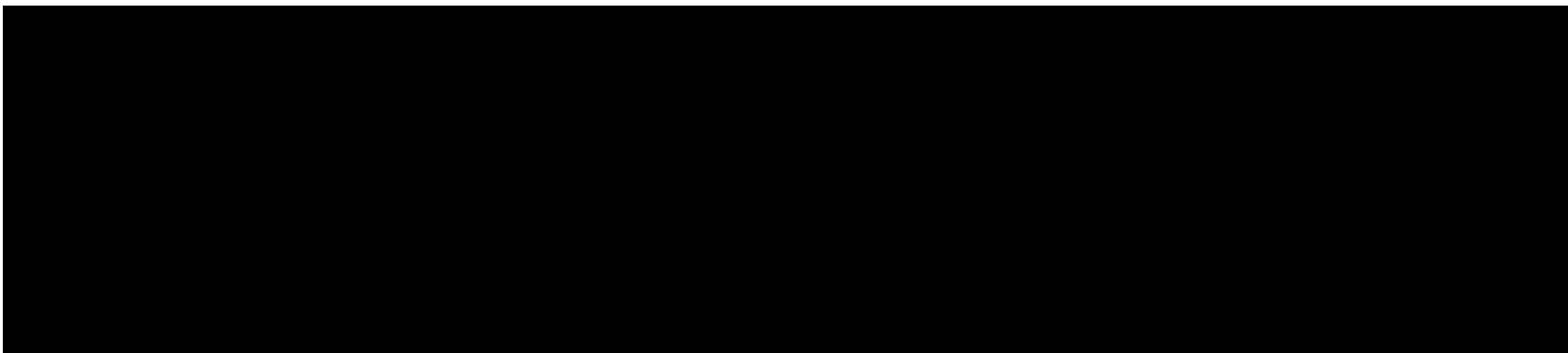

获取授权方式：

下载 ▾



License管理 申请授权 +

每页显示 10 搜索：

软件序列号	硬件序列号	型号	获取方式	创建时间	有效期	状态	关联激活码	操作	
7OZ807MX			123456	123456	IDP1000E	已授权	2015-08-26	1年	86

要打开或保存来自 49.4.162.68 的 448A5BF4F5C2.dat (153 字节) 吗?

打开(O) 保存(S) 取消(C)

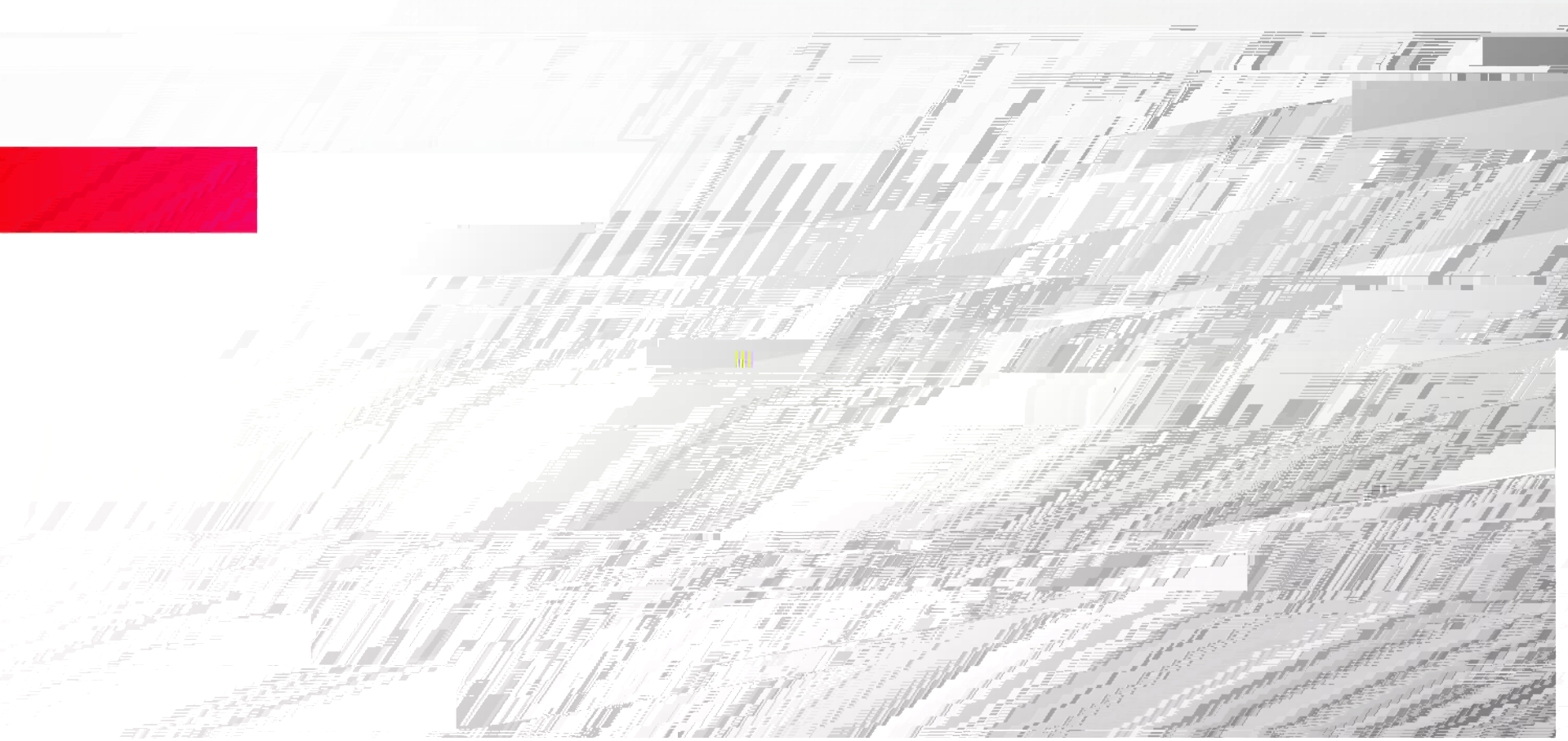





型号	RG-IDP 2000E
软件名称	RG-IDP系列入侵检测防御系统
软件版本	V1.0-R1.0.p0-20150914
软件序列号	001631F3F62A
序列号	H12345678
License	APPUP, IPSUP, UF, IPS, UFOL, FW

警告： 如果检测到异常，系统报警后，本系统即进入应急状态。

版本	状态	引用
RG-IDP-V1.0-R1.0.p0-20150818	<input type="checkbox"/>	<input type="checkbox"/>
RG-IDP-V1.0-R1.0.p0-20150827	<input checked="" type="checkbox"/>	<input checked="" type="checkbox"/>

